

Product Guide

Manufacturers

of Quality

Architectural

Fiberglass

Products



**FIBERGLASS
SPECIALTIES
INCORPORATED**

www.fsiweb.com

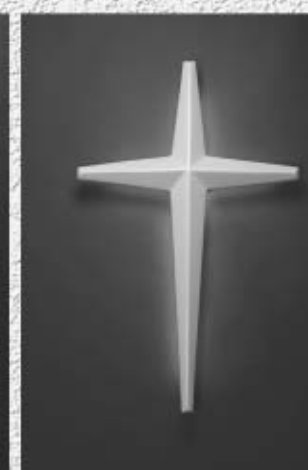
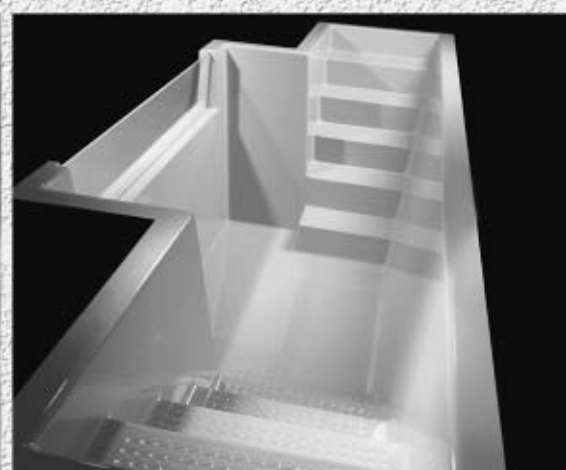

Table of Contents

Steeple	3-10
Steeple & Cupola Accessories	11
Cupola	12-14
Lighthouse	15
Domes	16
Finials	17
Steeple & Cupola Installation Guidelines	18-19
Baptistries	20-24
Baptistry Accessories	24-25
Baptistry Installation Guidelines	24
Baptistry Heaters	26-27
Optional Items	26
Wall & Roof Crosses	28

About the Company...

Founded in 1963, Fiberglass Specialties was one of the first manufacturers of fiberglass church baptistries, steeples, and wall crosses. Today we are the market leader, with the largest line of products in the industry. Our strong desire to improve our products and better serve our customers are the driving forces behind our constant innovation.

Fiberglass Specialties is a family owned business, now in its second generation. Owner and President Rocky Hall takes a hands-on approach not unlike that of his father, Howard Hall, who began the company over forty-five years ago.

We invite you to visit our 65,000 square foot manufacturing and office facility and see for yourself why Fiberglass Specialties is a name you can trust.

RULE OF THUMB—Architects generally select a steeple that is about the same height as the distance from the ground to the peak of the roof of the building.

NOTE: All measurements, weights, and drawings shown in the catalog are rounded off and approximate.

Steeple & Cupola Elements

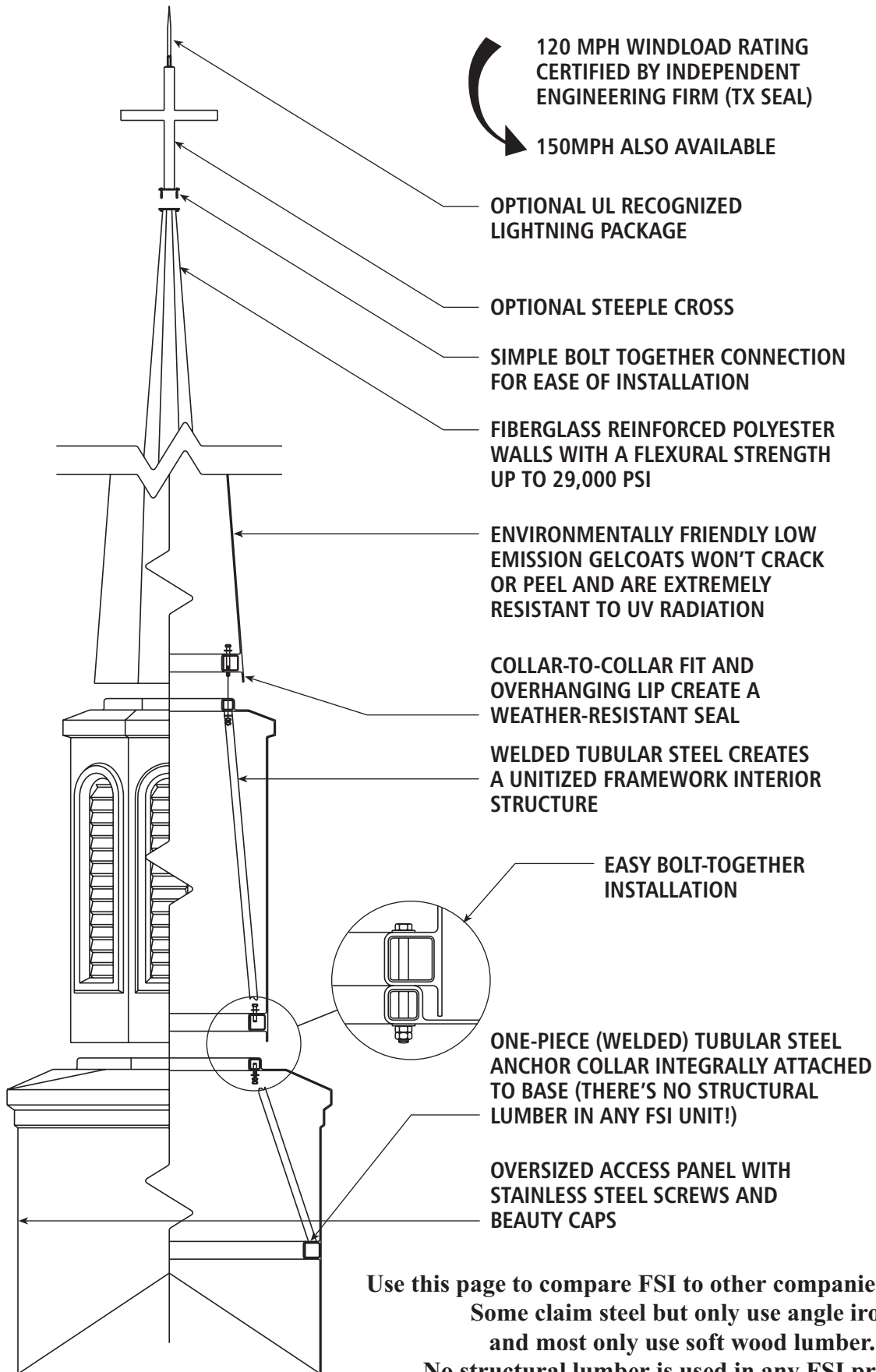

120 MPH WINDLOAD RATING
CERTIFIED BY INDEPENDENT
ENGINEERING FIRM (TX SEAL)

150MPH ALSO AVAILABLE

OPTIONAL UL RECOGNIZED
LIGHTNING PACKAGE

OPTIONAL STEEPLE CROSS

SIMPLE BOLT TOGETHER CONNECTION
FOR EASE OF INSTALLATION

FIBERGLASS REINFORCED POLYESTER
WALLS WITH A FLEXURAL STRENGTH
UP TO 29,000 PSI

ENVIRONMENTALLY FRIENDLY LOW
EMISSION GELCOATS WON'T CRACK
OR PEEL AND ARE EXTREMELY
RESISTANT TO UV RADIATION

COLLAR-TO-COLLAR FIT AND
OVERHANGING LIP CREATE A
WEATHER-RESISTANT SEAL

WELDED TUBULAR STEEL CREATES
A UNITIZED FRAMEWORK INTERIOR
STRUCTURE

EASY BOLT-TOGETHER
INSTALLATION

ONE-PIECE (WELDED) TUBULAR STEEL
ANCHOR COLLAR INTEGRALLY ATTACHED
TO BASE (THERE'S NO STRUCTURAL
LUMBER IN ANY FSI UNIT!)

OVERSIZED ACCESS PANEL WITH
STAINLESS STEEL SCREWS AND
BEAUTY CAPS

**Use this page to compare FSI to other companies' products.
Some claim steel but only use angle iron
and most only use soft wood lumber.
No structural lumber is used in any FSI product.**

Complete Steeple Units

All prices are FOB Henderson, Texas
Please call for freight rates

SB Series Steeples - One Piece Steeple Units

These one-piece steeples have been among our most popular models for many years.

Their simple, elegant design makes them suitable for a wide variety of architectural styles.



SB-10
10' Height, 30" Base
150 lbs
In Stock



SB-14
14' Height, 33" Base
175 lbs
In Stock



SB-19
19' Height, 40" Base
250 lbs

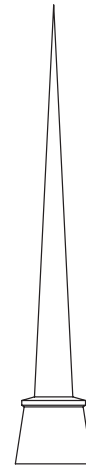

SB-24
24' Height, 47" Base
375 lbs

Shown with optional
cross cut-out

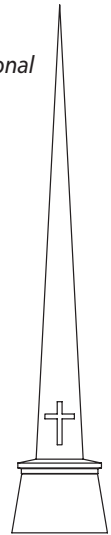

SB-28
28' Height, 59" Base
500 lbs

Steeple Unit #24B

Height: 18'
Base: 3'8"
450 lbs

One piece unit

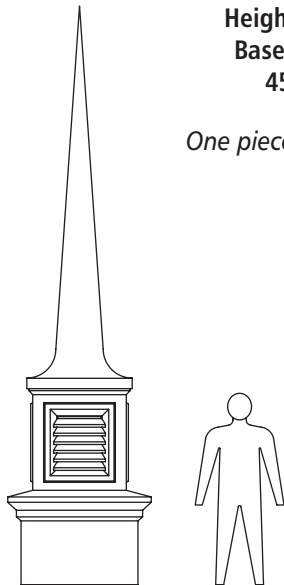

False louvers (square top)
Vented louvers (square top)
Krinklglass windows (square top)

Steeple Unit #23

Height: 21'
Base: 3'7"
400 lbs

Components:
Spire #817
Base Cupola #801

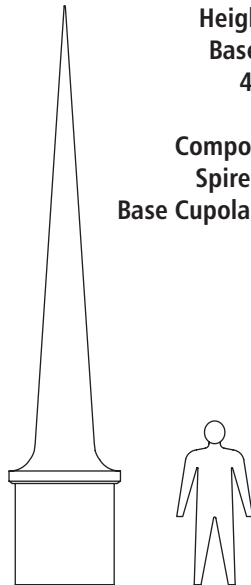

As Shown

Steeple Unit #6

Height: 23'
Base: 4'0"
445 lbs

Components:
Spire #118s
Base Cupola #301

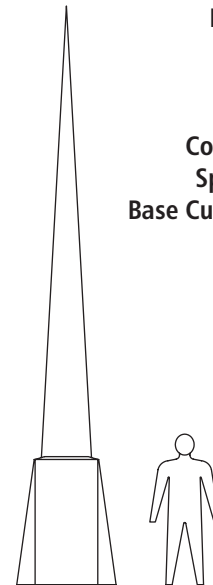

As Shown



Fiberglass steeples never need painting!

The gel-coat on your fiberglass steeples is an integral part of the laminate, so it can't crack and peel off like painted surfaces. Our "Armor Flex" gel-coats are extremely resistant to the sun's damaging ultraviolet rays.

Complete Steeple Units

All prices are FOB Henderson, Texas
Please call for freight rates

Steeple Unit #28

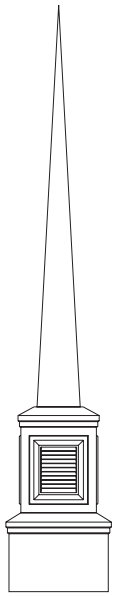

Height: 24'
Base: 4'0"
400 lbs

One piece unit



False louvers (square top)
Vented louvers (square top)
Krinklglass windows (square top)
Also available in round top

Steeple Unit #24

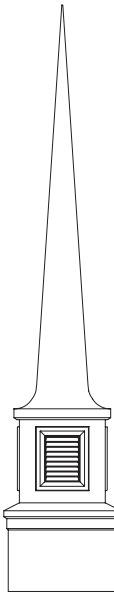

Height: 25'
Base: 4'7"
630 lbs

Components:
Spire #817
Base Cupola #802



False louvers (square top)
Vented louvers (square top)
Krinklglass windows (square top)
Also available in round top

Steeple Unit #5

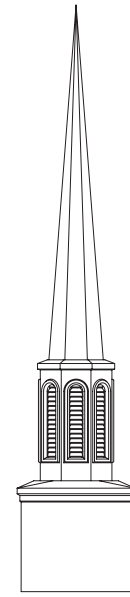

Shown w/ round top
and false louvers

Height: 27'
Base: 5'0"
750 lbs

Components:
Spire #616
Cupola: #602
Base Cupola #604



False louvers (round top)
Vented louvers (round top)
Krinklglass windows (round top)

Steeple Unit #22

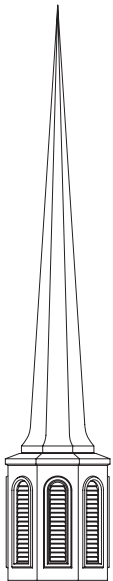

Height: 27' to 29'
Base: 4'8"
550 to 600 lbs

Components:
Spire #621
Base Cupola #601 EX

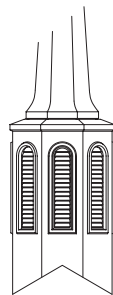

False louvers (round top)
Vented louvers (round top)
Krinklglass windows (round top)

Steeple Unit #27

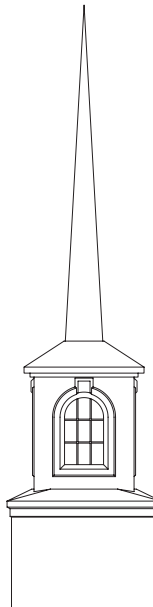

Height: 25'
Base: 6'0"
1085 lbs

Components:
Spire #114
Cupola #405
Base Cupola #607



Vented louvers (round top)
Krinklglass windows (round top)

Steeple Unit #33

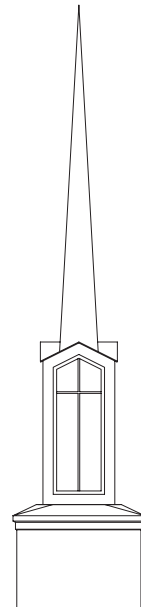

Height: 29'4"
Base: 6'0"
1025 lbs

Components:
Spire #116
Cupola #408
Base Cupola #607



Vented louvers
Krinklglass windows

Independent Third Party Engineering Certification –

Only Fiberglass Specialties, Inc. has had their engineering reviewed and certified by an independent third party engineering firm. All steeples are certified to withstand wind loads up to 120 mph. Engineering seals for all 50 states available for a slight additional charge. Engineered for 150 mph also available at additional cost.



Complete Steeple Units

All prices are FOB Henderson, Texas
Please call for freight rates

Steeple Unit #25

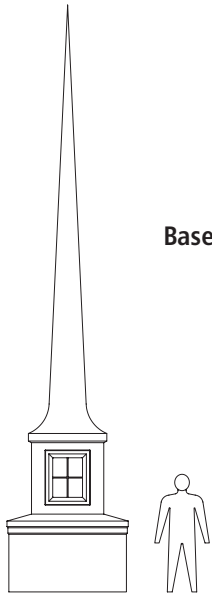

Height: 30'
Base: 6'0"
750 lbs

Components:
Spire #822
Base Cupola #803

False louvers (square top)
Vented louvers (square top)
Krinklglas windows (square top)
Also available in round top

Steeple Unit #4

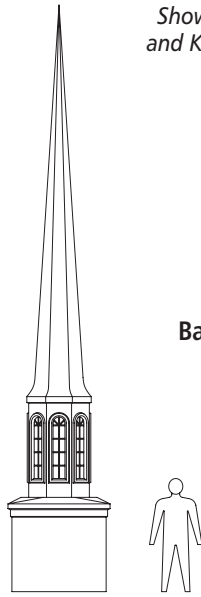

*Shown w/ round top
and Krinklglas window*

Height: 31'
Base: 5'0"
775 lbs

Components:
Spire #621
Cupola #603
Base Cupola #604

False louvers (round top)
Vented louvers (round top)
Krinklglas windows (round top)

Steeple Unit #2

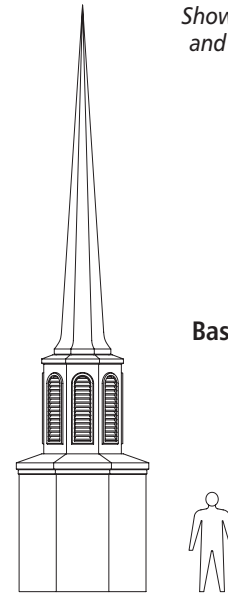

*Shown w/ round top
and vented louvers*

Height: 36'
Base: 7'8"
1330 lbs

Components:
Spire #621
Cupola #601
Base Cupola #704

False louvers (round top)
Vented louvers (round top)
Krinklglas windows (round top)

Steeple Unit #8

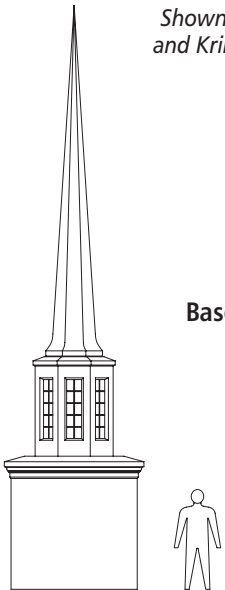

*Shown w/ square top
and Krinklglas window*

Height: 35'
Base: 7'6"
1350 lbs

Components:
Spire #621
Cupola #601
Base Cupola #703

As shown (square top)
False louvers (round top)
Vented louvers (round top)
Krinklglas windows (round top)

Steeple Unit #13

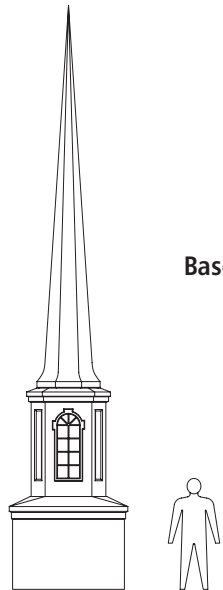

Height: 32'
Base: 6'0"
950 lbs

Components:
Spire #621
Cupola #605
Base Cupola #607

Vented louvers (round top)
Krinklglas windows (round top)

Steeple Unit #14

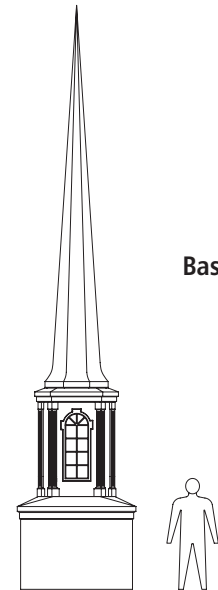

Height: 32'
Base: 6'0"
1000 lbs

Components:
Spire #621
Cupola #605C
Base Cupola #607

Vented louvers (round top)
Krinklglas windows (round top)



Each steeple is pre-fit for a smooth installation...

Our own 40' mounted crane stands next to our loading dock, allowing us to check the fit and alignment of each component of your steeple unit before loading onto the truck. This helps minimize costly delays during installation.

Complete Steeple Units

All prices are FOB Henderson, Texas
Please call for freight rates

Steeple Unit #20
Steeple Unit #21

Height: 36'
Base: 7'4"
1325 lbs

Components:
Spire #728
Cupola #709

Height: 32'
Base: 6'0"
850 lbs

Components:
Spire #724
Cupola #708

Steeple Unit #29

Height: 39'
Base: 6'9"
1250 lbs

Components:
Spire #621
Cupola #603
Cupola #205
Base Cupola #710

Vented louvers
Krinklglas windows

Steeple Unit #9

Height: 40'
Base: 7'6"
1500 lbs

Components:
Spire #726
Cupola: #601
Base Cupola #703

False louvers (round top)
Vented louvers (round top)
Krinklglas windows (round top)

Steeple Unit #1

Shown w/ round top and false louvers

Height: 42'
Base: 7'8"
1505 lbs

Components:
Spire #728
Cupola #701
Base Cupola #704

False louvers (round top)
Vented louvers (round top)
Krinklglas windows (round top)

Steeple Unit #7

Shown w/ gothic top and vented louvers

Height: 42'
Base: 7'6"
1525 lbs

Components:
Spire #728
Cupola #701
Base Cupola #703

Shown with optional gothic louvers

Gothic Top (optional)
False louvers (round top)
Vented louvers (round top)
Krinklglas windows (round top)

Steeple Unit #15

Height: 44'
Base: 7'6"
1725 lbs

Components:
Spire #728
Cupola #608
Base Cupola #703

Vented louvers (round top)
Krinklglas windows (round top)

Steel Anchoring...

One of the most critical stress points on a steeple is the point of attachment to the roof. While others use wood, we use tubular steel anchoring members (not angle steel) in all our steeple units for maximum strength and durability.



Complete Steeple Units

All prices are FOB Henderson, Texas
Please call for freight rates

Steeple Unit #19

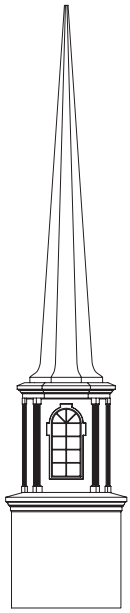

Height: 43'
Base: 7'6"
1785 lbs

Components:
Spire #728
Cupola #608C
Base Cupola #703

Vented louvers (round top)
Krinkglas windows (round top)

NEW! Steeple Unit #50

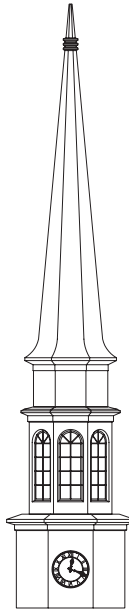

Height: 49'
Base: 10'0"
2500 lbs

Components:
Spire #1032
Cupola #1050
Cupola #1076

Vented louvers (round top)
Krinkglas windows (round top)

Steeple Unit #11

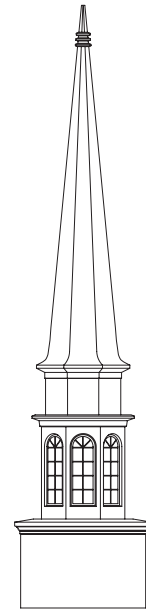

Height: 48'
Base: 10'0"
2600 lbs

Components:
Spire #1032
Cupola #1050
Base Cupola #705

Vented louvers (round top)
Krinkglas windows (round top)

Steeple Unit #12

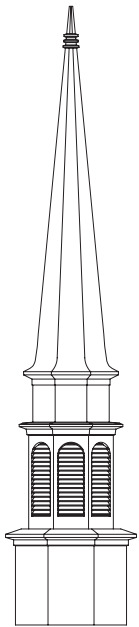

Height: 49'
Base: 8'9"
2500 lbs

Components:
Spire #1032
Cupola #1050
Base Cupola #1075

Vented louvers (round top)
Krinkglas windows (round top)

NEW! Steeple Unit #51

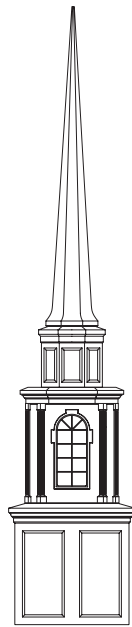

Height: 41'
Base: 7'6"
1525 lbs

Components:
Spire #621
Cupola #609
Cupola #608C
Base Cupola #703

Vented louvers
Krinkglas windows

Applied molding included!

Steeple Unit #30

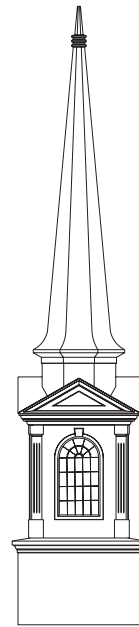

Height: 52'
Base: 10'0"
3300 lbs

Components:
Spire #1032
Cupola #208
Base Cupola #705

Vented louvers (round top)
Krinkglas windows (round top)



Specially formulated gel coats...

Because of the uniqueness of our products and large sales volume, FSI has gel coats specially formulated for exterior applications. Our low styrene extra hard gel coats maintain their color and resist hailstones.

Complete Steeple Units

All prices are FOB Henderson, Texas
Please call for freight rates

Steeple Unit #35

Height: 53'
Base: 7'6"
2450 lbs

Components:
Spire #728
Cupola #608C
Base Cupola #409

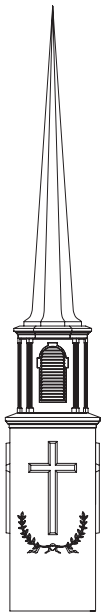

Unit shown with
optional wreath



Vented louvers
Krinklglas windows

NEW! Cross Base

This new base is adaptable to many spire and cupola combinations. The cross is raised 4" and can be painted an alternate color or made translucent with backlighting. An optional wreath is also available. SU 35 and SU 39 are just two examples. Consult factory for more information.

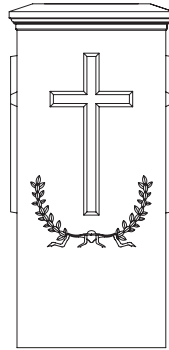

Components:
Cupola #409



Steeple Unit #39

Height: 54'
Base: 10'0"
3350 lbs

Components:
Spire #728
Cupola #701
Cupola #409R
Base Cupola #705

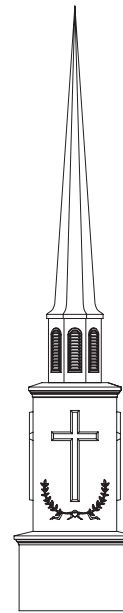

Unit shown with
optional wreath



False louvers
Vented louvers
Krinklglas windows

Steeple Unit #10

Height: 54'
Base: 10'0"
2750 lbs

Components:
Spire #728
Cupola #701
Cupola #706
Base Cupola #705

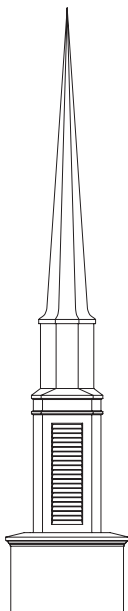

False louvers
Vented louvers
Krinklglas windows

NEW! Base & Cupola

FSI's new base and cupola can be matched with many spire and upper cupola combinations for a more modern appearance. SU10 and SU42 are just two examples. Consult factory for more information.

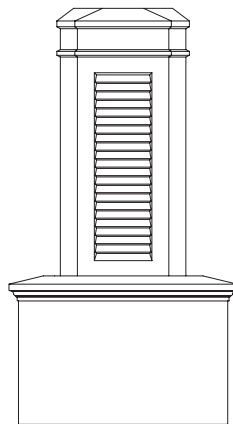

Steeple Unit #42

Height: 47'
Base: 10'0"
2950 lbs

Components:
Spire #621
Cupola #601
(Shown with
optional square top)
Cupola #706
Base Cupola #705

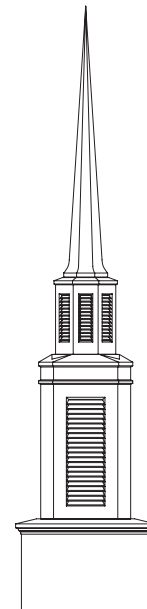

Cupola #601
False louvers
Vented louvers
Krinklglas windows
Cupola #706
False louvers
Vented louvers
Krinklglas windows

Complete Steeple Units

All prices are FOB Henderson, Texas
Please call for freight rates

#714 Base

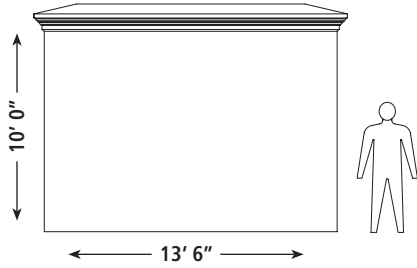

Looking to increase the height or visual impact of your steeple?

Try adding our extra large base to a steeple or cupola. Consult factory for more information.

(Note: Escorted Load)

NEW! Clock Base

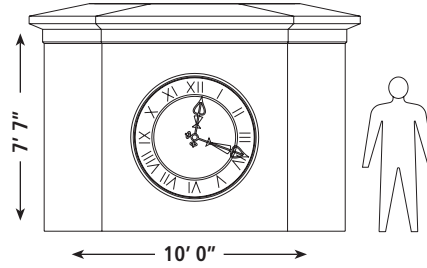

Shown with optional 4' clock

FSI's new clock base can be adapted to several FSI cupolas and steeples. Consult factory for details.

Cupola 1076

Carillon Screen

Vented louvers deflect much of the sound and clarity coming from an expensive carillon system. FSI's Carillon screen will allow 90% sound transmission.

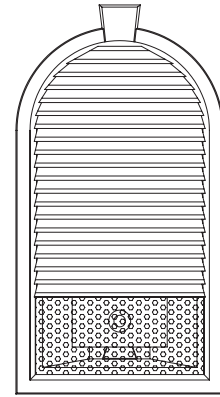

Modifications

Many FSI products can be modified to create a unique appearance.

Consult factory for pricing on molding, special windows, extending molds, etc.

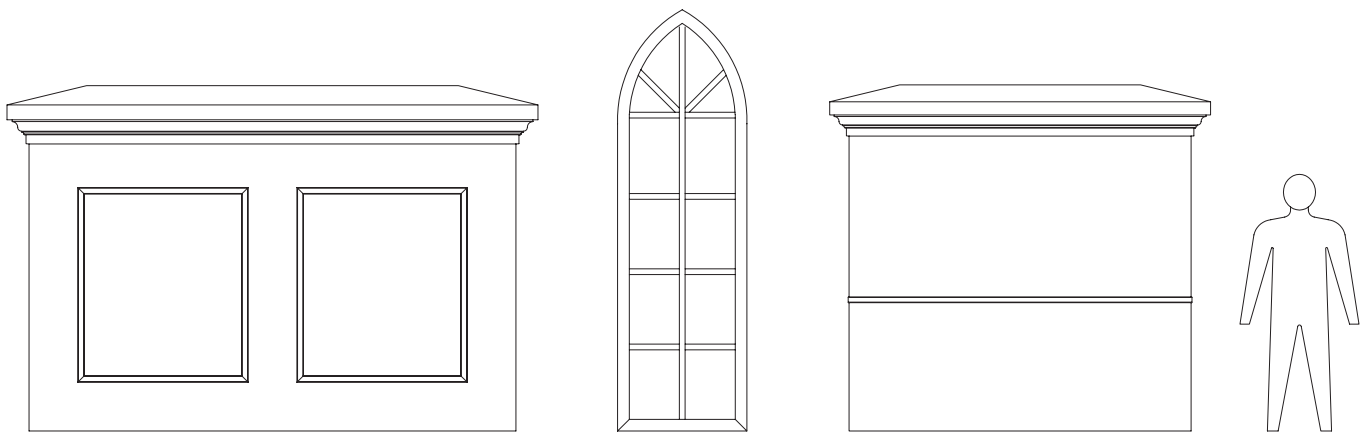

Spire Crosses

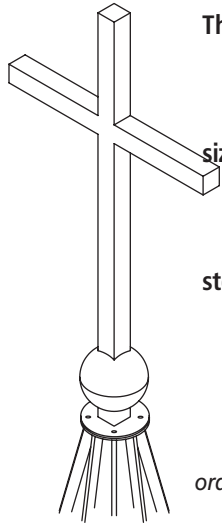

These crosses are designed to be added to any of our steeple or cupola units.

All have a 2" square aluminum body size, and may be ordered with or without lightning package.

To further enhance the look of your steeple, add a 6" or 9" ball to your spire cross.

Celtic Cross Also Available.
Consult Factory

Cross must be ordered with steeple

24" Cross	Item #2-SS
36" Cross	Item #3-SS
48" Cross	Item #4-SS
6" Diameter Ball	Item #Ball-6
9" Diameter Ball	Item #Ball-9

Lightning Package

Lightning Package for attachment to customer's lightning protection system. Package consists of a 12" x 5/8" nickel plated, copper air terminal, coupling, and 17 gauge woven copper cable to base of unit.

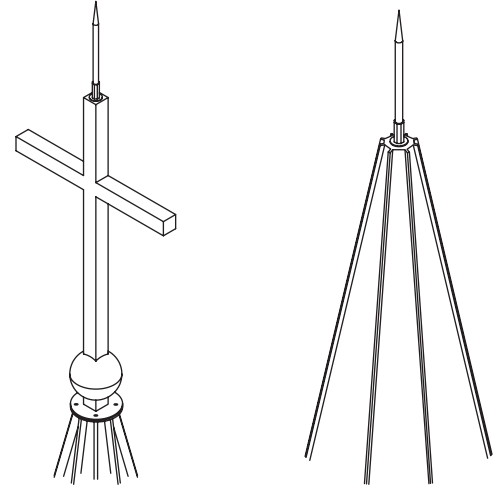

Decorative Urns

Designed to coordinate with our steeple units, they may be used alone or with one of our railing systems.



U-25

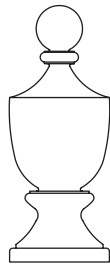

U-11
U-15
U-20

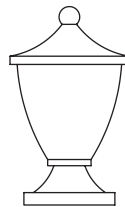

U-12
U-24
U-36

Railings

Available in three popular styles, these railing systems are made from durable, low maintenance fiberglass or aluminum.

Whether used atop a tower at the base of your steeple, or used independently, these railings will provide many years of trouble-free service.

Urns and Balls available for post top decoration. Consult factory for pricing.

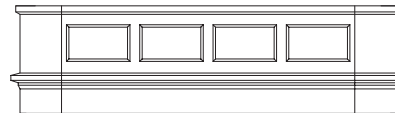

Solid Panel Railing
(Number of panels varies by length)

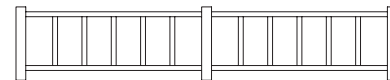

Picket Railing

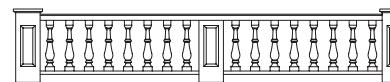

Balustrade Railing